

An Earthquake Preparedness Guide

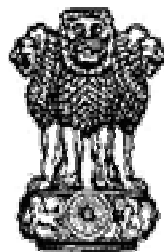

सत्यमेव जयते

National Disaster Management Division
Ministry of Home Affairs
North Block, New Delhi, India

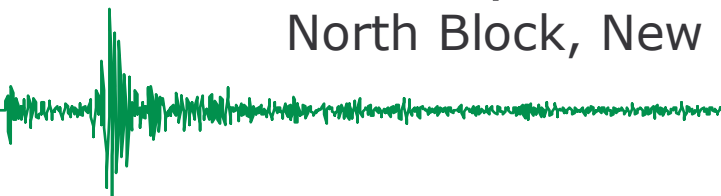



An Earthquake Preparedness Guide

A ready reckoner for Home Dwellers

Past earthquakes in our country brought home the harsh reality that earthquakes don't kill people, unsafe buildings do. About 60% of the land area of our country is susceptible to damaging levels of seismic hazard. We can't avoid future earthquakes, but preparedness and safe building construction practices can certainly reduce the extent of damage and loss. To take necessary action it is mandatory for every citizen to have elementary knowledge of what is an earthquake, forces acting on structures, remedial measures to be taken for structural safety and knowledge of what to do before, during and after an earthquake.

This guide will serve as a reference tool to sensitize citizens about the issues concerning preparedness measures for an earthquake.

1. What is an earthquake?

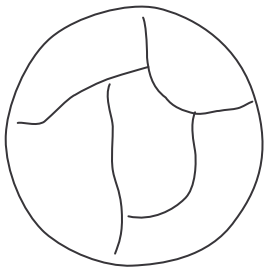

The surface of earth is made of several plates

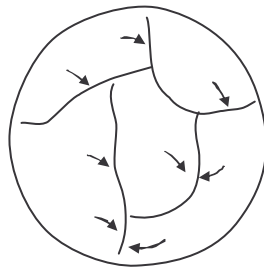

These plates move all the time

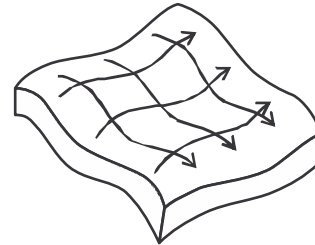

Due to this movement of plates the energy stored is suddenly released when rocks get crushed under stress and spreads in the form of waves inside the ground creating earthquakes

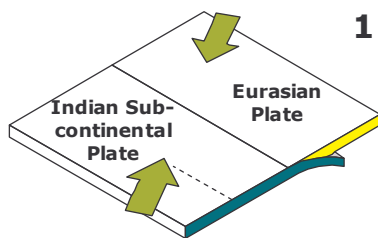

Movement of Plates

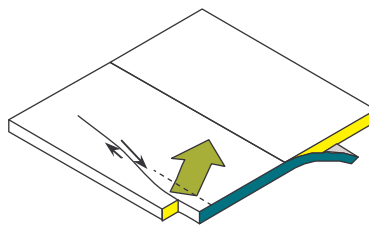

Building of stress

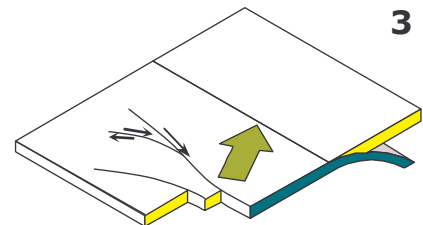

Release of Energy

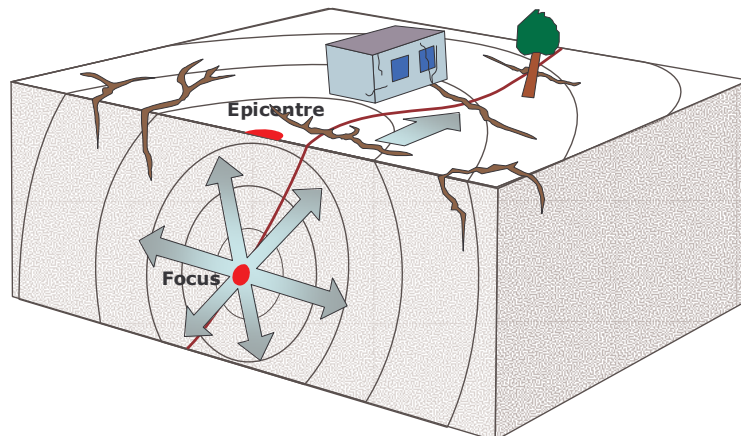

At the joint of two interacting plates the rocks get crushed under great stress causing earthquake waves in all directions.



2. What causes damage to the building?

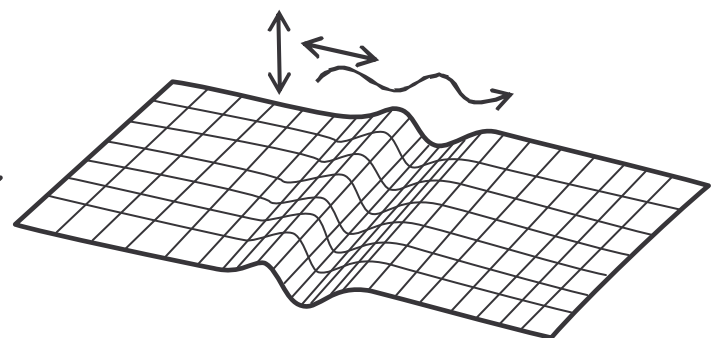
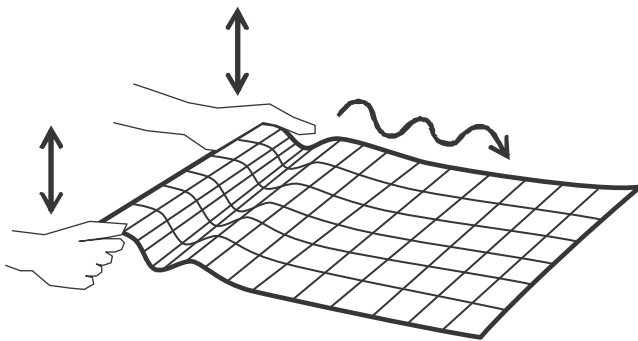
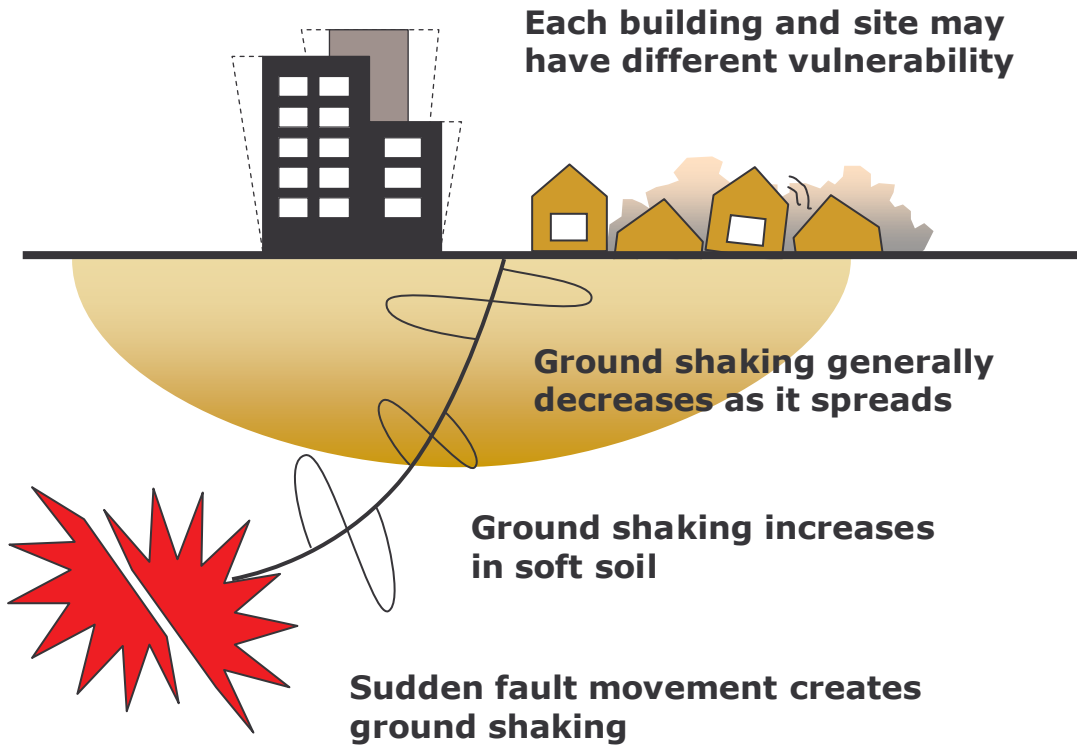

Imagine a sheet of cloth. By shaking it at one end, a wave is formed. This is what happens in an earthquake.

Because of the wave, horizontal force acts on the building. For this sideways movement the building has to be specifically designed.

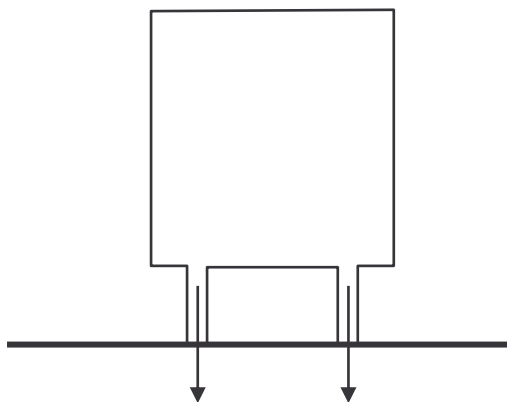

Normally the weight of the building travels vertically down to the ground. All buildings are designed for this weight.

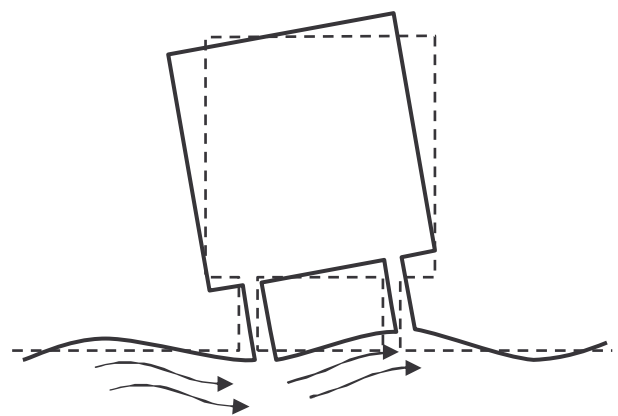

Crack, and in some cases failures, occur if the shape, material and details of the construction are not adequate to withstand sideways shaking.



3. Different structural systems: a Basic Guide

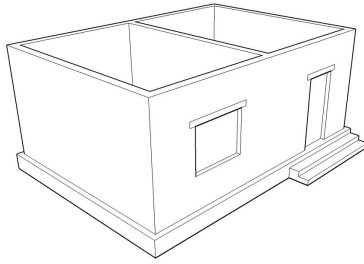

Load Bearing Structure

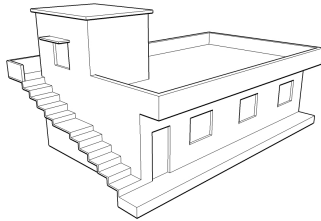

(generally ground floor + 1 storey)

Tenement

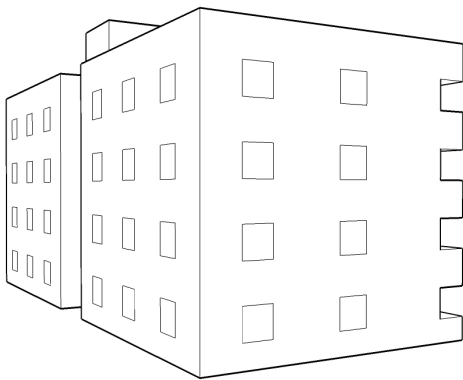

Mid-rise Flats

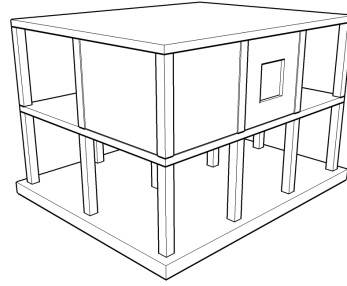

Reinforced Concrete (R.C.) Frame structure

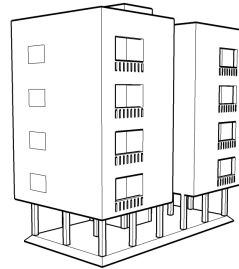

Mid-rise flats

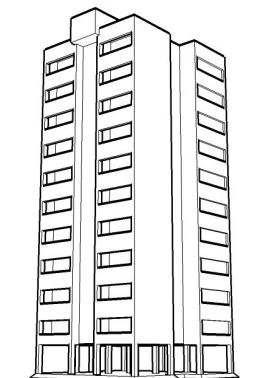
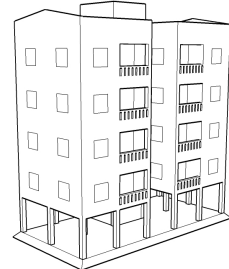

Simple R.C. frame structure

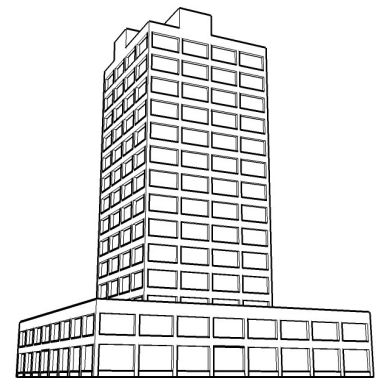

R.C. frame structure with Podium

Towers

4. What Happens during an earthquake?

A. Load bearing Structure

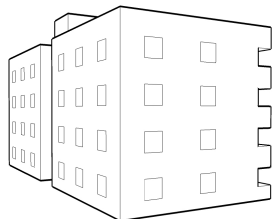

Mid rise flats

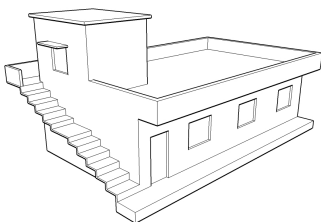

Single Storey residential House

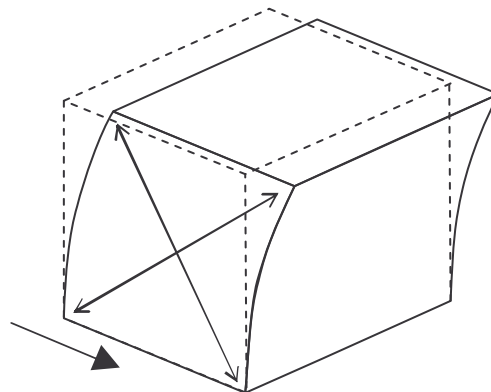

The load bearing walls act as a stiff box. The weakest point in this box is the openings for doors and windows and the junction between the wall and slab.



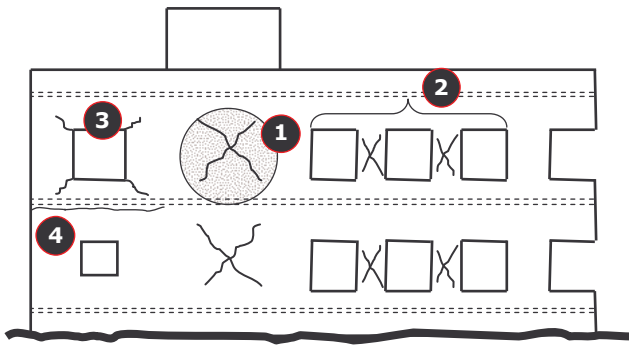

- Most serious damage occurs when diagonal cracks appear in the walls [1] themselves; they should be checked by an engineer immediately.
- Cracks are most likely to appear at the corner of the openings diagonally [3], in piers between consecutive windows [2] placed horizontally.
- The shorter these cracks are, the less damage has occurred.
- Also check for horizontal cracks between slab and walls [4]. These are not risky to the basic stability of the structure.

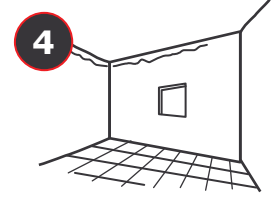
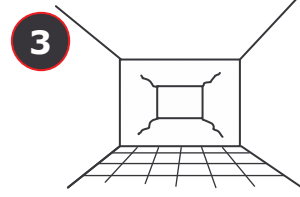
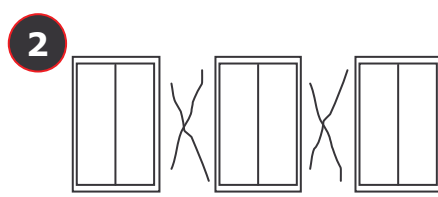
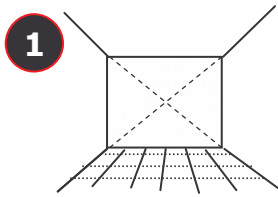

B. Frame Structure

Open Ground Storey/Buildings on Stilts

The RC frame structures where the ground storey is left open without any partition walls (of either Masonry or, RC) between the columns are called Open Ground Storey buildings or, buildings on stilts. In this case it is relatively flexible and weak in the ground storey.

The presence of walls in the upper storeys makes them much stiffer than the open ground storey. Thus they move almost together as a single block. As the columns in the open storey are not strong enough in resisting sideways shaking from the earthquake, they get severely damaged, subsequently leading to collapse of the super structure.

Experience has shown that buildings on stilts do not perform well in earthquakes unless the column and beam connections on the ground floor have been specially designed to withstand the shaking load. A few options are shown in the figure below.

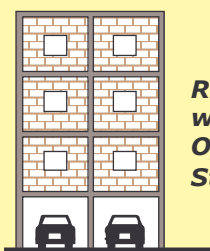

R.C. structure with Open Ground Storey

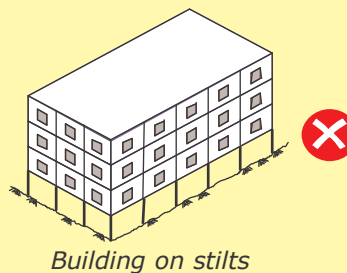

Building on stilts

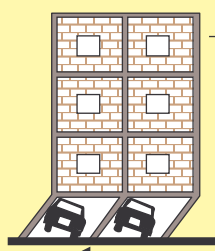

Open ground storey getting damaged during an earthquake

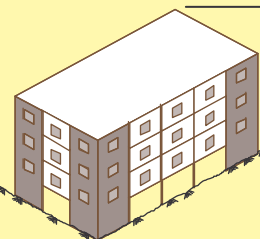

Providing R.C. Shear Wall

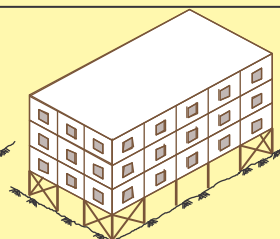

Bracings in the columns of open ground storey

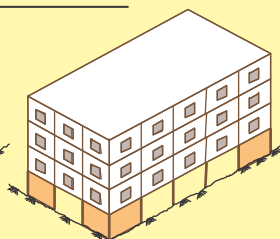

Providing Brick infills between columns



a. Mid-rise framed Structures without open ground storey

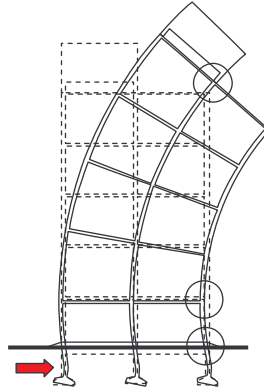
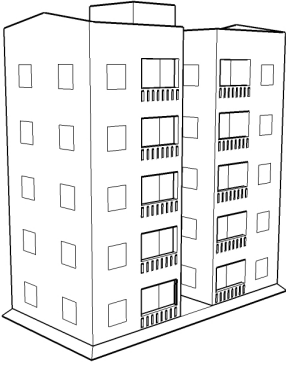

RCC frames bend due to horizontal forces. This affects the joints of the columns and beams. They may crack.

Mid-rise framed Structures, G + 4

b. Mid-rise Frame Structures with projected balcony and with open ground storey

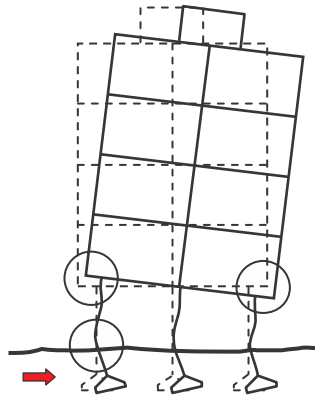
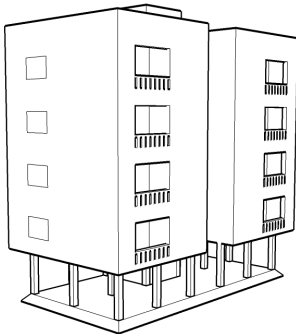

During the earthquake it is the columns that carry the upper part of the building. These columns are affected the most during the shaking.

In this case the frame above the ground floor is projected from the columns and enclosed with walls.

c. Tower Block with open ground storey

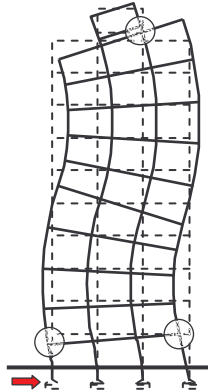
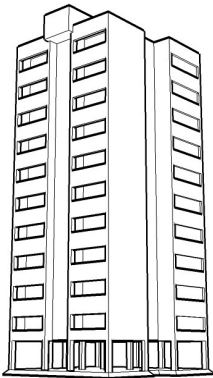

Due to the height, the horizontal force during an earthquake may cause the buildings to sway in both directions.

Beyond ground + 4 floors

d. Tower Block with Podium

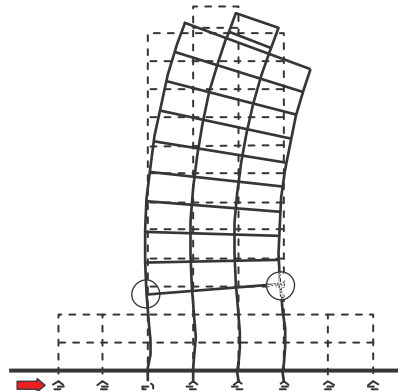
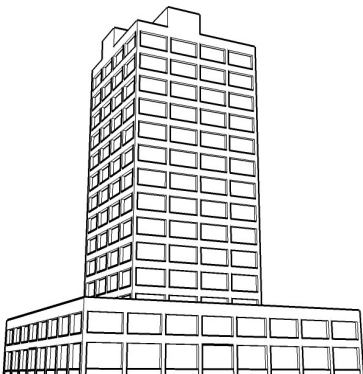

The podium tends to move horizontally during an earthquake. At the same time the tower will bend due to the horizontal force. The most affected area is the floor above the podium. This level should be checked carefully.

In such cases the Podium reduces the height of the tower.



5. Inspect your Building

If you live in a multistoried building and if you are not sure it has been designed to resist earthquake forces, the **first step** that needs to be taken is to sensitize your fellow residents and the neighbourhood about the damages and losses they may face in an earthquake.

The next step would be to get your building reviewed for earthquake safety by a competent and experienced structural engineer.

Who is a Structural Engineer?

A structural engineer is one who is trained and experienced to understand how buildings are constructed and how they behave and be able to recognize weaknesses which may cause them to collapse in an earthquake event. They will be able to survey your building and advise you on whether strengthening is necessary and if so how it can be done. Structural engineers will be able to supervise or, get a competent person for supervision of repair work on your behalf to make sure that it is done properly. Select a structural engineer registered with the Local Authority.

Sequence in which Structural Elements are to be checked

- A. Corner Columns and beams
- B. Peripheral Columns and beams
- C. Cantilevered beams (for Balcony covered framed buildings)
- D. Stair walls and columns and lift walls
- E. Columns at upper levels.
- F. Water tanks
- G. Infill and partition Walls
- H. As a precautionary measure the beams and columns as well as their junctions at all levels must be checked.

6. Non-structural Elements

Ways to reduce damage to and injury from the contents of your home.

- 1 Brackets at top or, sides secure the shelves from toppling off.

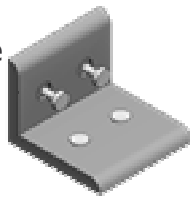

- 2 Metal or, wire guardrails will also help keep objects from falling off open shelves

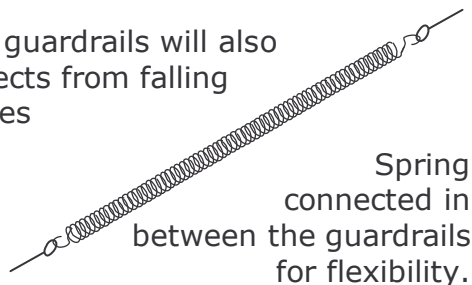

- 3 Metal plastic or, wood ledge barriers prevent objects from sliding off the shelves.

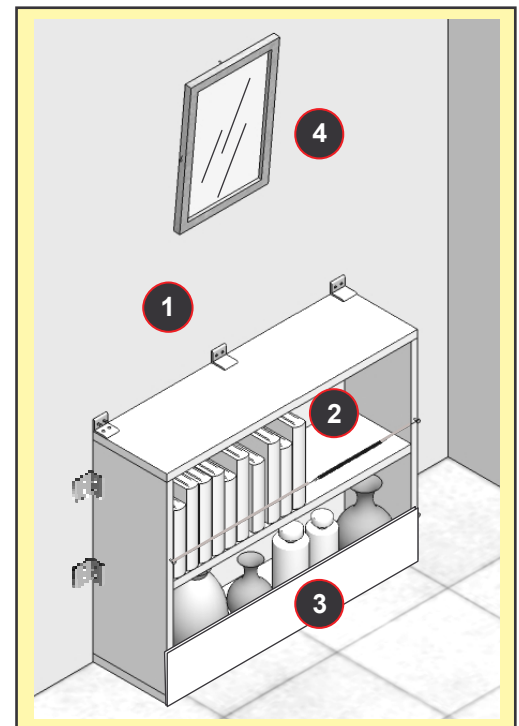

4

Closed screw-eye

Picture frames, bulletin boards and mirrors will fall during an earthquake if they are not securely fastened to the wall.

Do screw *closed screw-eye* to hang up picture frame/ bulletin boards/ mirrors.

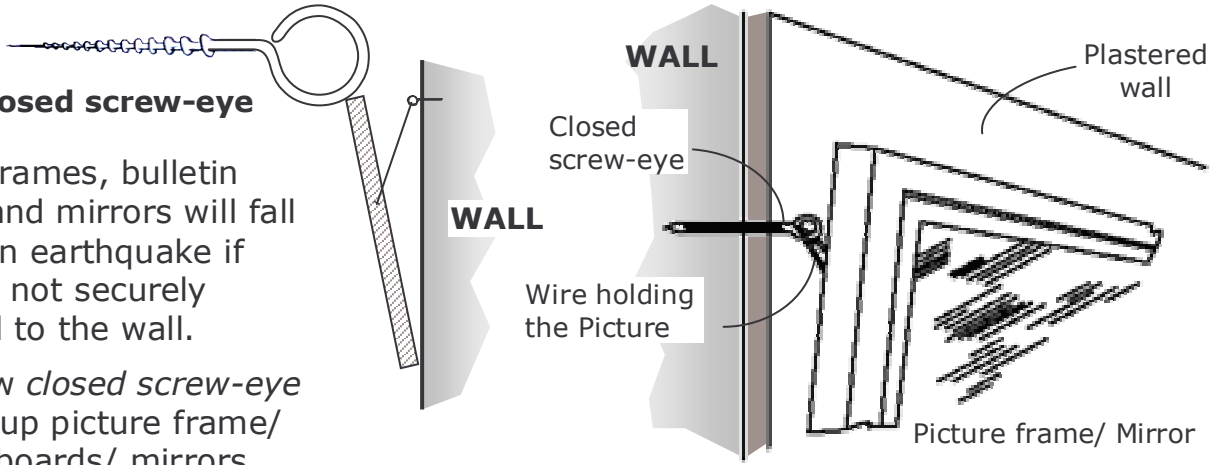

5

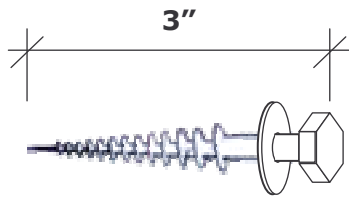

Screw and washer

A typical water heater weighs between 30 to 60 kilograms when full. A sudden jolt and/or the rolling motion that accompanies most earthquakes can cause them to topple over.

Wrap heavy-gauge metal bands or nylon strapping 1½ times around the tank. Secure this band or strapping to the wall with several ¼ inch by 3 inches or longer lag screws/ expansion bolts with washers.

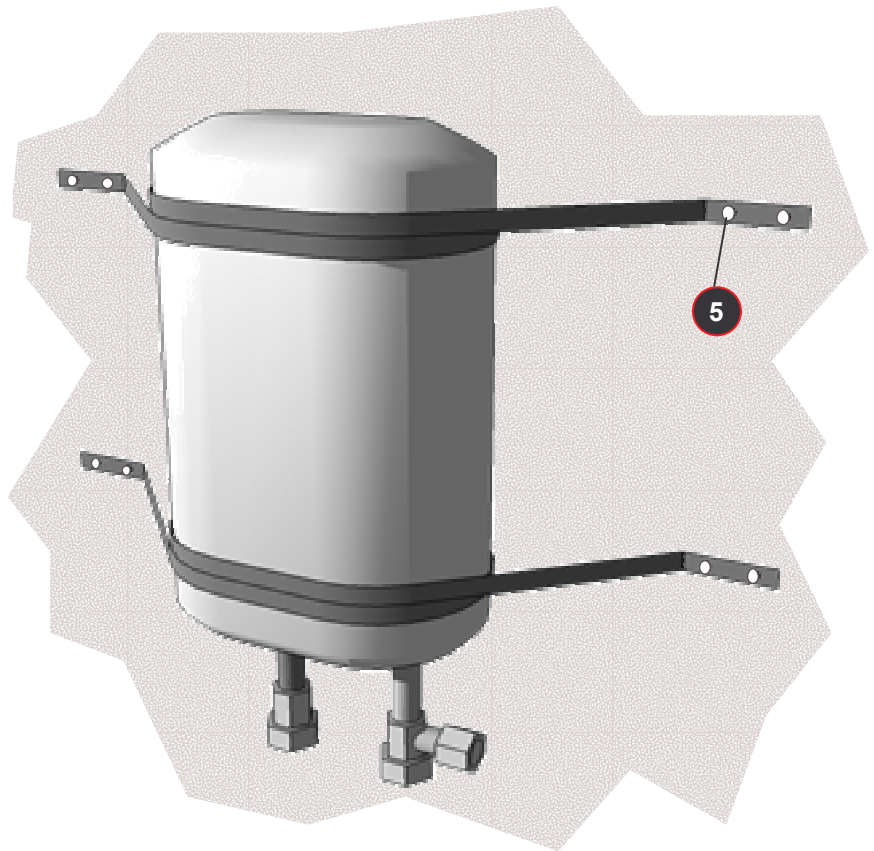

6

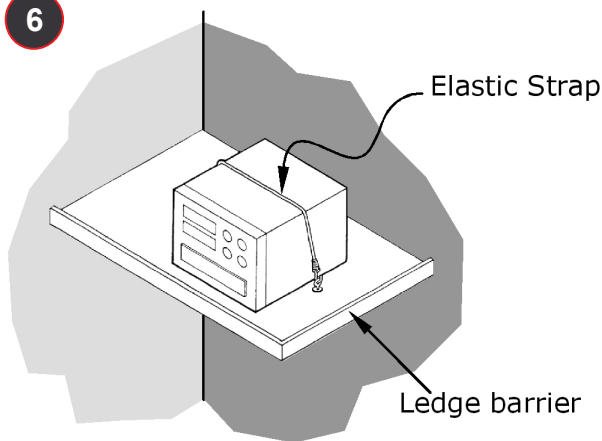

Tie down attachment of radio equipment

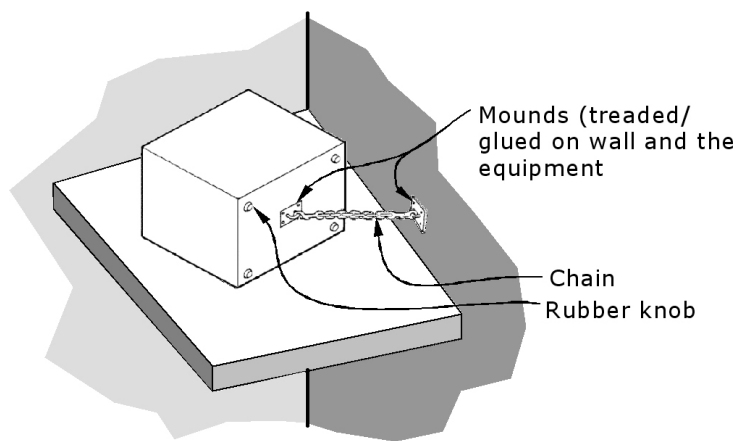

Detachable light chain attachment of radio equipment to the wall



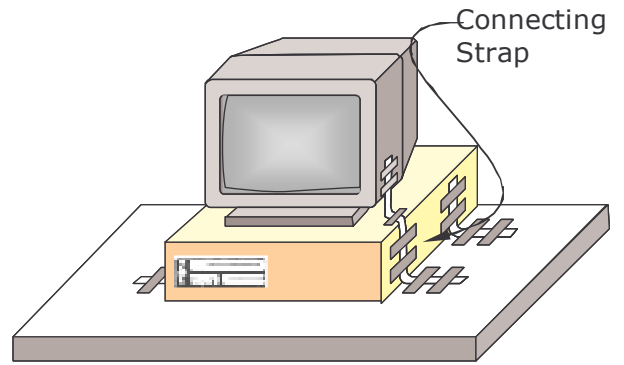
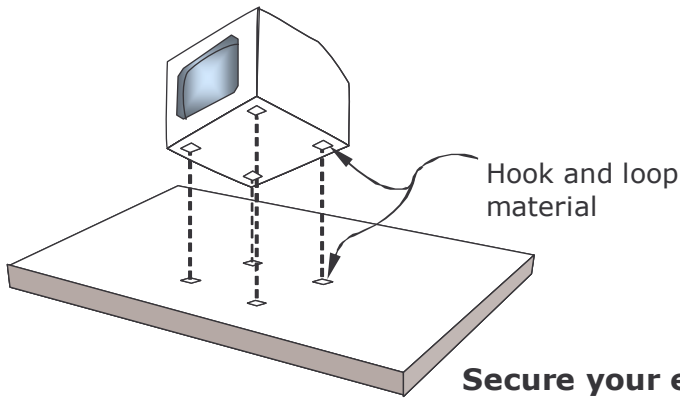

Secure your equipment/ computer in the work place

Heavy objects such as televisions, computers and stereos are usually placed on top of cabinets, bookcases and tables. Fasten these items so they will not slide off during an earthquake. Such simple structural measures are vital to maintain safety during an earthquake.

7 Secure your water tank

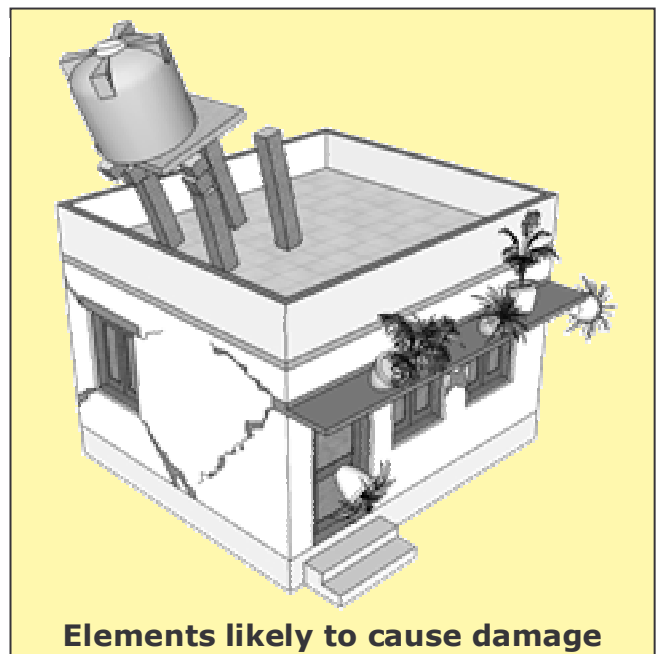
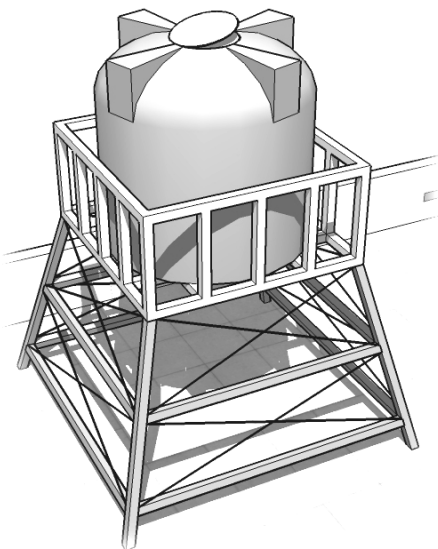

8 Secure the flower pots from falling off

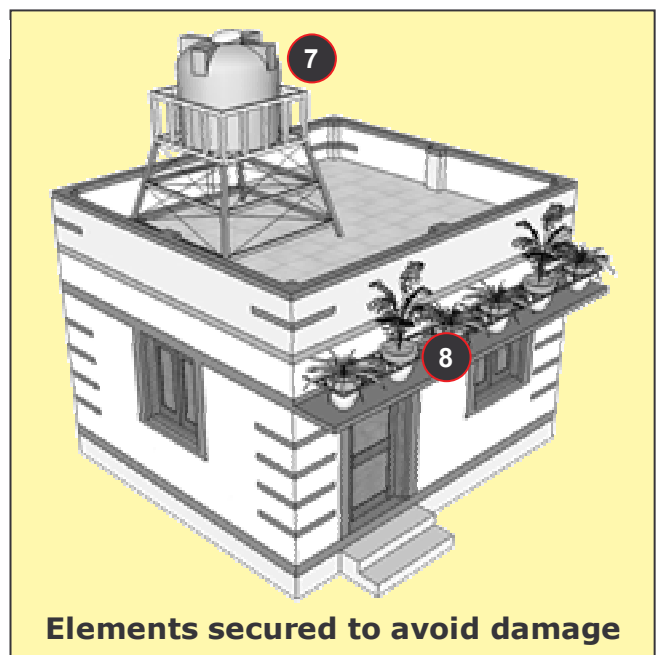
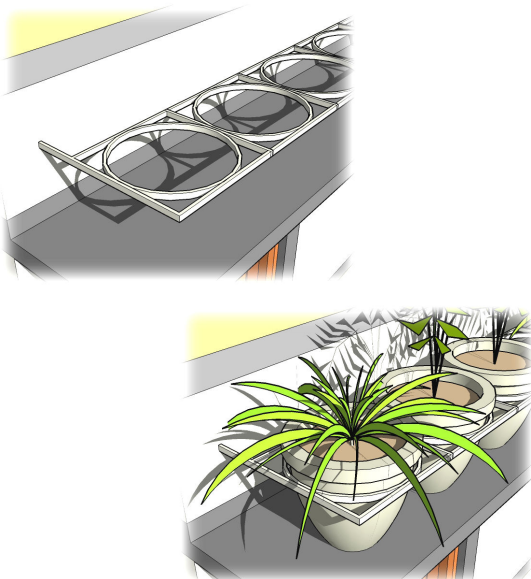

7. Strengthen/Retrofit your building

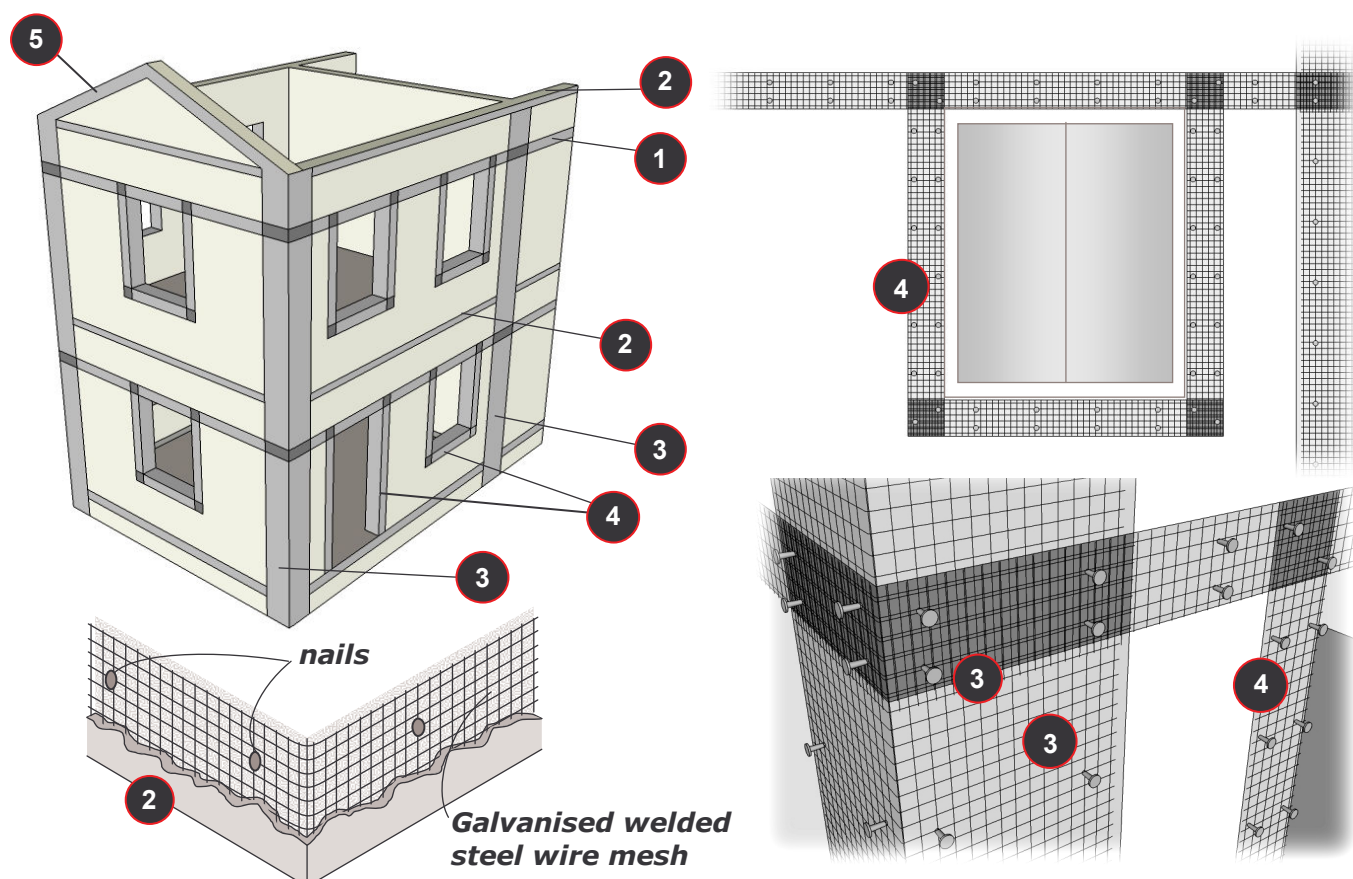

- 1 - Horizontal Seismic Belts just above the lintels of Door and Window opening
- 2 - Horizontal belts just below the roof
- 3 - Vertical Seismic Belts at wall junctions (L & T junctions)
- 4 - Seismic belt around doors and windows containing galvanized welded steel wire mesh as reinforcement
- 5 - Seismic belts around the gable wall

STEPS TO LAY THE SEISMIC BELTS IN YOUR HOUSE

- Step - 1: - Remove plaster in the height of the belt.
- Step - 2: - Rake out mortar joints to 12 – 15 mm depth.
- Step - 3: - Clean the surface and wet it with water.
- Step - 4: - Apply neat cement slurry and thereafter apply the first coat of 12 mm thickness cement mortar. Roughen the surface of the plaster before initial hardening.
- Step - 5: - Fix the mesh with 150 mm long nails at about 300 mm apart while the first coat of plaster is in its initial hardening stage.
- Step - 6: - Apply second coat of plaster of 16 mm thickness.

8. What to do BEFORE an earthquake?



Always remember:

“Earthquakes don’t kill people, unsafe buildings do.”

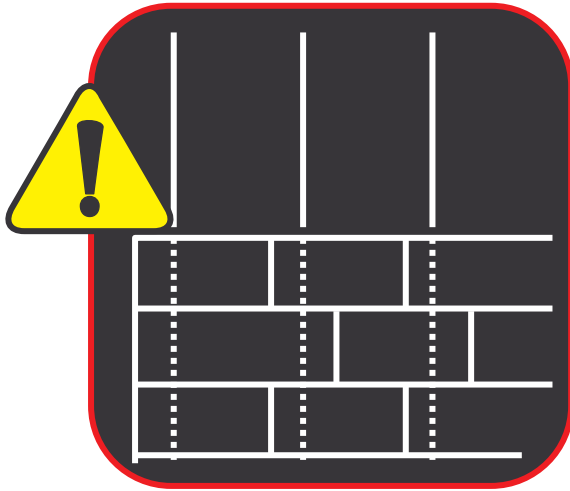

Reinforced brick Masonry

Be sure that the proper structural design and engineering practices are followed while constructing a house.

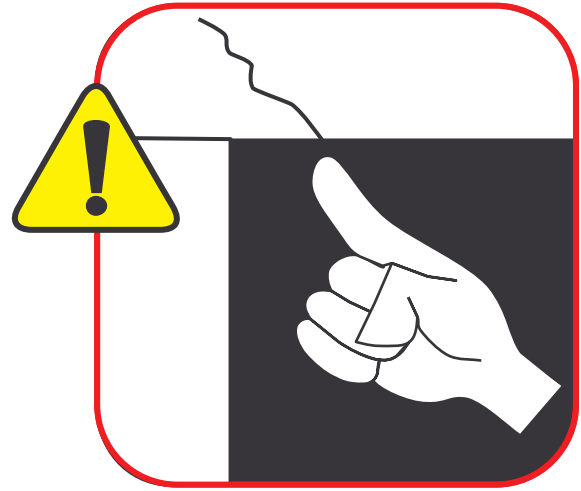

Cracks being developed over the openings

Evaluate the structural soundness of buildings; strengthen/ retrofit if necessary.

Three Points to remember:

1. While building your house make sure it is designed for your safety. See that your building is designed and built as per the norms laid by the **BIS codes**.

Bureau of Indian Standards (BIS) has published the following seismic codes:

IS: 1893 (Part I), 2002, Indian Standard Criteria for Earthquake Resistant Design of Structures (5th Revision)

IS: 4326, 1993, Indian Standard Code of Practice for Earthquake Resistant Design and Construction of Buildings (2nd Revision)

IS: 13827, 1993, Indian Standard Guidelines for Improving Earthquake Resistance of Earthen Buildings

IS: 13828, 1993, Indian Standard Guidelines for Improving Earthquake Resistance of Low strength Masonry Buildings

IS: 13920, 1993, Indian Standard Code of Practice for Ductile Detailing of Reinforced Concrete Structures Subjected to Seismic Forces

IS: 13935, 1993, Indian Standard Guidelines for Repair and Seismic Strengthening of Buildings

2. If you are living in a house/flat, work to improve its safety.
3. If you are looking for a place to stay, you should look for safety.

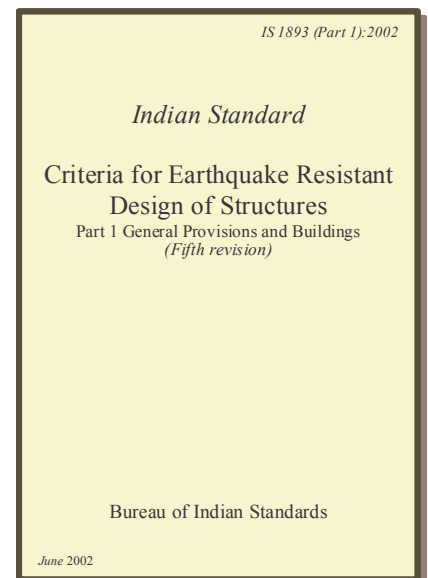

The Bureau of Indian Standards has laid down code of practice for design criteria of structures.



9. What to do DURING an earthquake?

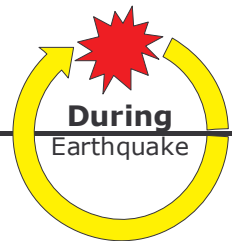

Drop

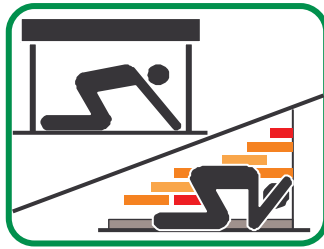

Cover



Hold

During earthquakes, drop to the floor, take cover under a sturdy desk or table, and hold on to it so that it doesn't move away from you. Wait there until the shaking stops.



If you are in a structurally sound building, stay there.



If you are inside an old weak structure, take the fastest and safest way out.

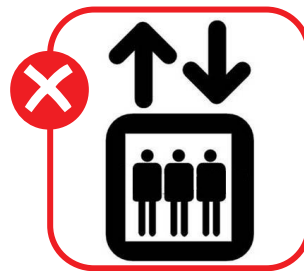

Do not use elevators.



Instead take the staircase to reach open space



Do not panic; stay calm and take necessary action.



Do not rush to the exit point. Get out calmly in an orderly manner.



Move away from power lines, posts, walls, false ceiling, parapet, falling flower pots and other elements that may fall or, collapse.



Stay away from buildings with glass panes.



If you are on a steep hillside, move away in case of landslides and falling rocks.



When driving a vehicle pull to the side of the road and stop.



Do not attempt to cross bridges/flyovers, which may have been damaged.





10. What to do AFTER an earthquake?

Checklist of DO's and DON'Ts

DO's

- Check for fire and, if any, have it controlled.
- Check your water and electrical lines for defects.
- If any damage is suspected, turn the system off from the main valve or, switch.
- Clean up household chemical spills, toxic and flammable materials to avoid any chain of unwanted events.
- Gather information and necessary instructions from battery operated radios.
- Obey Public safety precautions.
- Leave a message stating where you are going if you must evacuate your residence.

- Take your earthquake **survival kit** with you.
- It should contain all necessary items for your protection and comfort.

DON'Ts

- Don't enter partially damaged buildings. Strong aftershocks can cause further damage to the buildings and weak structures may collapse.
- Don't use your telephone to call relatives and friends, call only for medical help.
- Don't use your two-wheeler/car to drive around the areas of damage. Rescue and relief operations need the road for mobility.

Until your building is declared safe, or, repairs have been complete:

1. Do not fill the overhead tank completely.
2. Do not carry out haphazard repairs. Repairs should be done only under the supervision of a structural engineer.
3. Do not put additional supports without the guidance of an experienced/qualified structural engineer.
4. Do not use the lift until it has been checked and certified by the lift company.

11. Some Important Facts

- Prediction of earthquakes is not possible. Do not listen to or, spread rumours.
- Expect aftershocks. Aftershocks are normally less intense and gradually die out.
- Long term strengthening or, retrofitting must be done to avoid future failures. The technology, expertise and the codes of practice for this exist in the country.
- The extra cost of earthquake resistant features in severe earthquake zone for masonry buildings shall be 4-6 % and for R.C. buildings (4-8 storeys) would be 5-6 %.
- Retrofitting of buildings not initially designed for earthquake will cost 2 to 3 times as much as the extra cost of the earthquake resistant features in the new buildings.

References:

1. Going Back to Your Home - An Earthquake Primer for City Dwellers, CEPT Ahmedabad
2. Marikina Safety Program - Public Information Toolkit



Notes





Concept, Design and Illustrations by
Jnananjan Panda and Anup Karanth

Prepared under the guidance of
Professor Anand S. Arya
National Seismic Advisor



National Disaster Management Division
Ministry of Home Affairs
North Block, New Delhi, India

Tel: 91 11 2309 3178, 2309 4019; **Fax:** 91 11 2309 3750, 2309 2763;
E-mail: ndmindia@nic.in; dsdm@nic.in; **Website:** www.ndmindia.nic.in



Prepared under the URBAN EARTHQUAKE VULNERABILITY REDUCTION PROJECT [UEVRP]
GoI – UNDP Disaster Risk Management Programme